

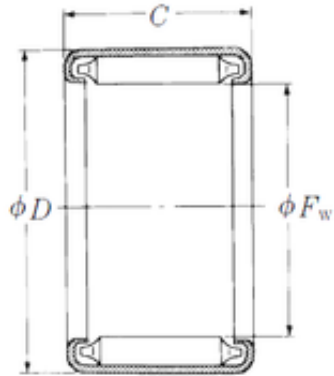

Timken BEARINGS INDUSTRY

NSK B-59 needle roller bearings



Bearing No. B-59

Size	7.938x12.7x14.27 mm
Bore Diameter	7,938 mm
Outer Diameter	12,7 mm
Width	14,27 mm
Fw	7,938 mm
D	12,7 mm
C	14,27 mm
Weight	0,0064 Kg
Basic dynamic load rating (C)	8,05 kN

B-59 Bearing 2D drawings and 3D CAD models